

Data Sheet

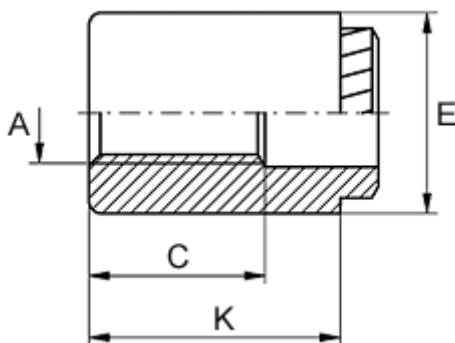

Article number: 12510600040100
Description: KLEE-coil 510 600 040.100
M4 Hardened, zinc-pl.

Measures



Female thread A	= M4
Height K	= 10
Hole diameter +0.1	= 6.4
Min distance to edge	= 3.3
Min material thickness	= 1.5
Outer diameter E	= 8
Thread length	= 9